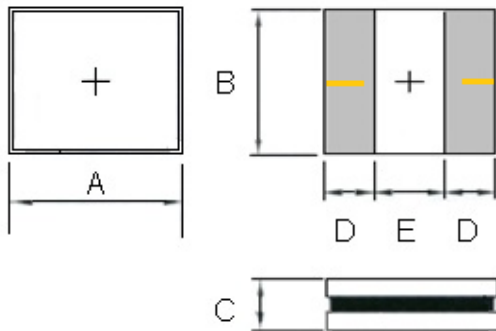

ITEM P/N	PN252012T-SERIES	TEST INSTRUMENT	Agilent4291B / Agilent4338B
PRODUCT	Power Inductor	TEST FREQUENCY	1 MHz / 0.2V

PACKING DIMENSIONS (mm)

PN252012	Dimensions
A	2.5 ± 0.3
B	2.0 ± 0.35
C	1.25 MAX
D	0.85 REF
E	0.80 REF

EXPLANATION OF PART NUMBERS

1	2	3	4	5	6	7	8	9	10
P	N	25	20	12	T	R	4	7	M
①			②		③		④		⑤

1. Product Name
2. Dimensions
3. Material
4. Inductance Code
5. Inductance Tolerance (N = 30% , M = 20%)

ELECTRICAL CHARACTERISTICS

HUNGTRON Part Number	Inductance (uH)	Test Frequency (Hz)	DCR (Ω) typ.	DCR (Ω) Max.	I sat (A) typ.	I sat (A) Max.	I rms (A) typ	I rms (A) Max.
PN252012T-R47□	0.47	1M	0.025	0.035	4.30	4	3.9	3.7
PN252012T-1R0□	1	1M	0.042	0.052	3.00	2.8	2.8	2.6
PN252012T-2R2□	2.2	1M	0.08	0.09	2.20	1.9	1.9	1.7
PN252012T-3R3□	3.3	1M	0.12	0.144	1.80	1.6	1.6	1.45
PN252012T-4R7□	4.7	1M	0.2	0.24	1.45	1.3	1.35	1.25
PN252012T-100□	10	1M	0.38	0.46	0.95	0.85	0.85	0.7
PN252012T-150□	15	1M	0.5	0.6	0.80	0.6	0.75	0.65
PN252012T-220□	22	1M	0.87	0.95	0.65	0.6	0.6	0.55

Storage temp. and humidity : -40 to +85°C ,70%RH max

Note :

- When ordering please specify tolerance and packaging codes.
- L:Agilent/HP4291B+Agilent/HP16197A, 1MHz/200mV
- RDC:Digital Milliohm Meter Agilent/HP4338B
- Isat & Irms : Microtest 6377, 1MHz/200mV
- Isat & Irms : Microtest 6377, 1MHz/200mV

ITEM P/N	PN252012T-SERIES	TEST INSTRUMENT	Agilent4291B / Agilent4338B
PRODUCT	Power Inductor	TEST FREQUENCY	1 MHz / 0.2V

Note :

- Isat for Inductance drop 30% from its value without current typical.
- Irms for a 40°C rise above 25°C ambient typical.
- If Use wave soldering is there will be some risk.(Crack · unwitting& Mark Shed)
- Re-flow soldering temperatures below 240 degrees,there will be unwitting risk
- Operating Temperature Range -40°C to +125°C(Including self-temperature rise)
- When total area of exposed wire occurring to each sides is not greater than 75% of coating resin area, that is acceptable.

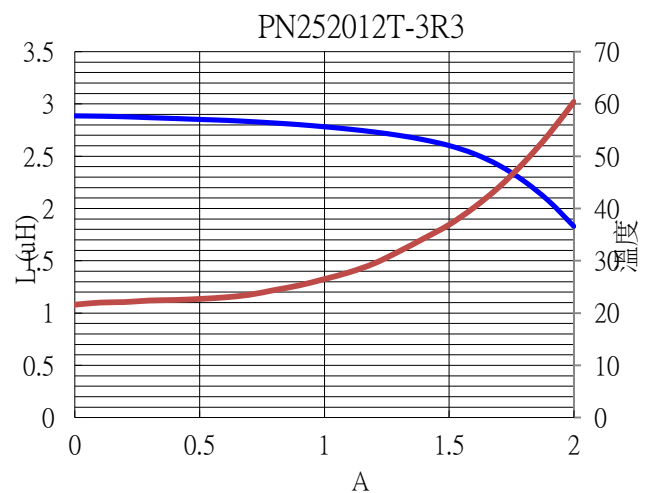
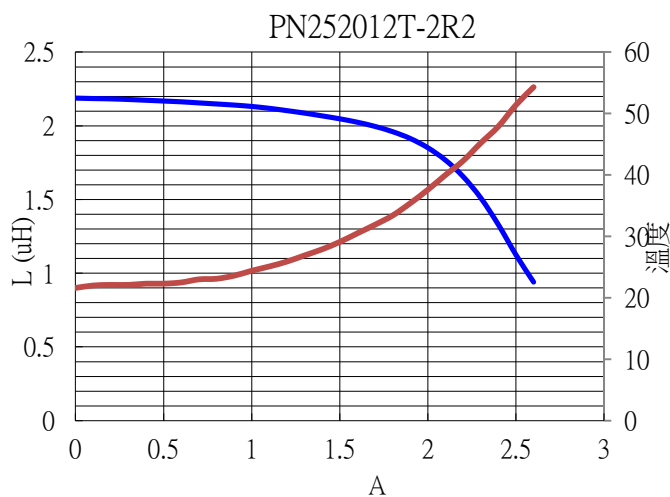
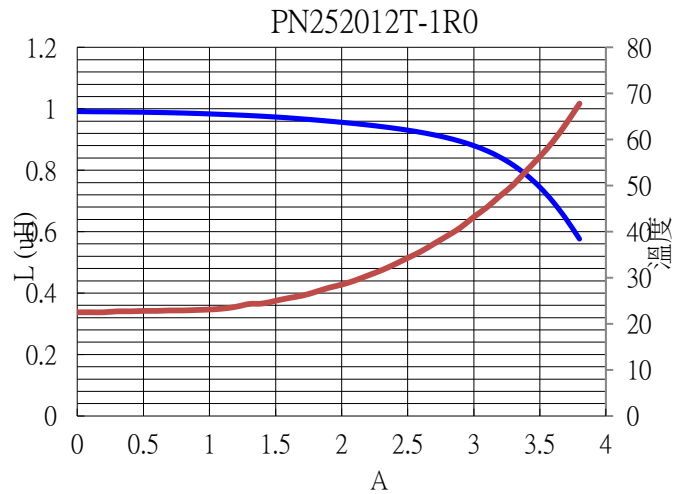
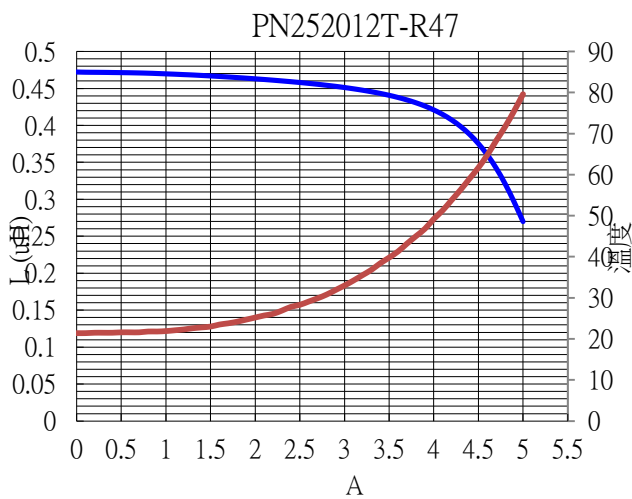
PERFORMANCE CURVES

ITEM P/N	PN252012T-SERIES	TEST INSTRUMENT	Agilent4291B / Agilent4338B
PRODUCT	Power Inductor	TEST FREQUENCY	1 MHz / 0.2V

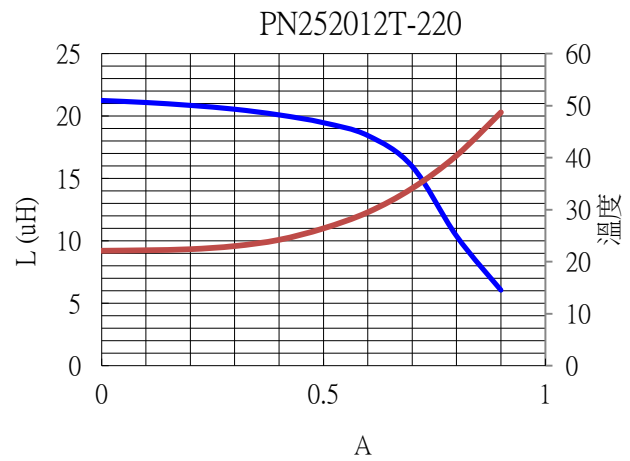
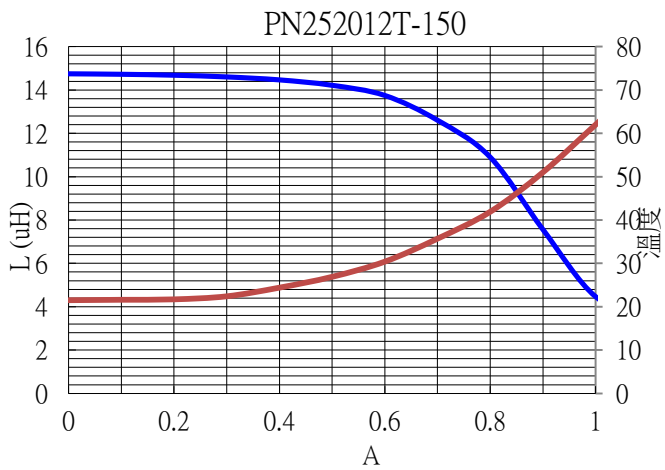
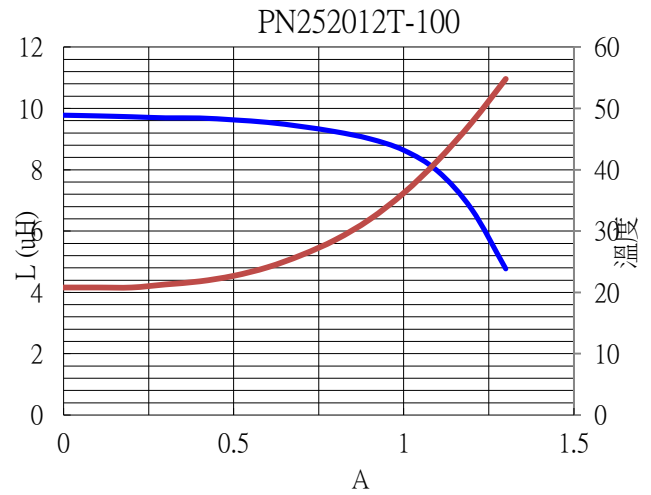
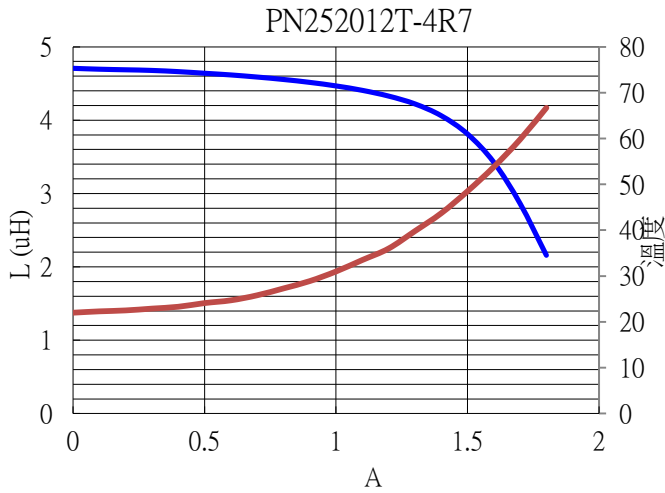
PERFORMANCE CURVES

ITEM P/N	PN252012T-SERIES	TEST INSTRUMENT	Agilent4291B / Agilent4338B
PRODUCT	Power Inductor	TEST FREQUENCY	1 MHz / 0.2V

Overhang acceptance description

Side overhang (A) is less than or equal to 20% width of component termination area (W) or 20% width of land (P), whichever is less.

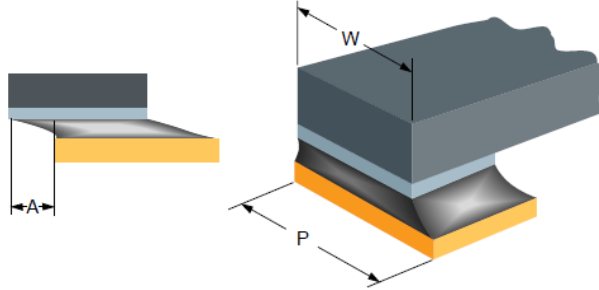
**Material List**

No.	Description	Specification
a.	Core	Metal Core
b.	Coating	Epoxy
c.	Termination	Tin Pb Free
d.	Wire	Enameled Copper Wire

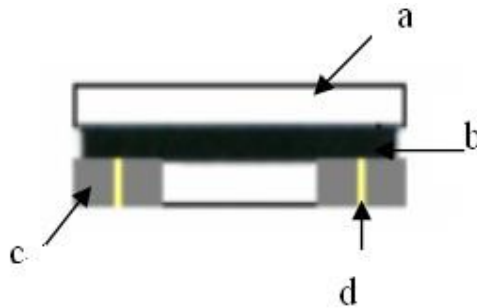

ITEM P/N	PN252012T-SERIES	TEST INSTRUMENT	Agilent4291B / Agilent4338B
PRODUCT	Power Inductor	TEST FREQUENCY	1 MHz / 0.2V

Reliability and Test Condition

Item	Performance	Test Condition
Operating Temperature	-40~+105°C (Including self-temperature rise)	

Electrical Performance Test

Inductance L	Refer to standard electrical characteristic list	Agilent-4291, Agilent-4287 Agilent-4192, Agilent-4285
Q		
SRF		Agilent-4291
DC Resistance		Agilent-4338
Rated Current	Base on temp. rise & $\Delta L/LOA \leq 30\%$.	Saturation DC Current (Isat) will cause LO to drop approximately $\Delta L(\%)$.
Temperature Rise Test	ΔT 40°C Max	Heat Rated Current (Irms) Will cause the coil temperature rise approximately $\Delta T(^{\circ}C)$ without core loss. 1. Applied the allowed DC current. 2. Temperature measured by digital surface thermometer

Mechanical Performance Test

Resistance to Soldering Heat MIL-STD-202 METHOD 210	1. Inductors shall be no evidence of electrical and mechanical damage. 2. Inductance : within $\pm 10\%$ of initial value	Temp.: 260 \pm 5°C Time: 10 \pm 1.0 Sec
Solderability Test ANSI/J-STD-002	More than 95% of terminal electrode should be covered with solder.	<p>After fluxing, component shall be dipped in a melted solder bath at 235\pm5°C for 4\pm1 seconds.</p>

CHARACTERISTICS

RoHS
COMPLIANT

ITEM P/N	PN252012T-SERIES	TEST INSTRUMENT	Agilent4291B / Agilent4338B
PRODUCT	Power Inductor	TEST FREQUENCY	1 MHz / 0.2V

Reliability and Test Condition

Item	Performance	Test Condition												
Reliability Test														
Humidity Test MIL-S TD-202 METHOD 103		1. Temperature : 40±2°C 2. Humidity : 90 ~ 95% 3. Time : 500 ±8hrs 4. Measured at room temperature after placing for 2 to 3 hrs												
Thermal Shock Test MIL-S TD-202 METHOD 107	1. Visual examination : No mechanical damage 2. Inductance : within±10% of initial value													
High Temperature Life Test MIL-STD-202 METHOD 108		1. Temperature : 85±2°C 2. Time : 500±8hrs 3. Measured at room temperature after placing for 2to3 hrs												
Humidity Resistance Test MIL-S TD-202 METHOD 103	<p>Conditions for 1 cycle</p> <table border="1"> <thead> <tr> <th>Step</th> <th>Temperature(°C)</th> <th>Times(min.)</th> </tr> </thead> <tbody> <tr> <td>1</td> <td>-55±2</td> <td>30±3</td> </tr> <tr> <td>2</td> <td>Room</td> <td>Within5</td> </tr> <tr> <td>2</td> <td>85±5</td> <td>30±3</td> </tr> </tbody> </table> <p>Total: 100 cycles Measured at room temperature after placing for 2 to 3 hrs</p>	Step	Temperature(°C)	Times(min.)	1	-55±2	30±3	2	Room	Within5	2	85±5	30±3	Temperature: 40±2°C Humidity: 90~ 95% 3. Time: 500±8hr. 4. Recovery: 2 to 3hrs of recovery under the standard condition after the removal from test chamber.
Step	Temperature(°C)	Times(min.)												
1	-55±2	30±3												
2	Room	Within5												
2	85±5	30±3												
Low temperature Storage Test JE SD22-A119		1. Temperature : -40±2°C 2. Time : 500±8hrs 3. Measured at room temperature after placing for 2to3 hrs												
Random Vibration Test MIL-S TD-202 Method 204	Appearance: Cracking, shipping and any other defects harmful to the characteristics should not be allowed. Inductance : within±10%	Frequency: 10-55-10Hz for 15 min. Amplitude: 1.52mm Directions and times: X, Y, Z directions for 15 min. This cycle shall be performed 12 times in each of three mutually perpendicular directions (Total 9hours).												

ITEM P/N	PN252012T-SERIES	TEST INSTRUMENT	Agilent4291B / Agilent4338B
PRODUCT	Power Inductor	TEST FREQUENCY	1 MHz / 0.2V

Soldering and Mounting**Soldering**

Mildly activated rosin fluxes are preferred. terminations are suitable for re-flow soldering systems.
If hand soldering cannot be avoided, the preferred technique is the utilization of hot air soldering tools.

Solder re-flow:

Recommended temperature profiles for re-flow soldering in Figure 1.

Soldering Iron(Figure 2):

Products attachment with a soldering iron is discouraged due to the inherent process control limitations. In the event that a soldering iron must be employed the following precautions are recommended.

- Preheat circuit and products to 150°C
- Never contact the ceramic with the iron tip
- Use a 20 watt soldering iron with tip diameter of 1.0mm
- 355°C tip temperature (max)
- 1.0mm tip diameter (max)

Reflow Soldering

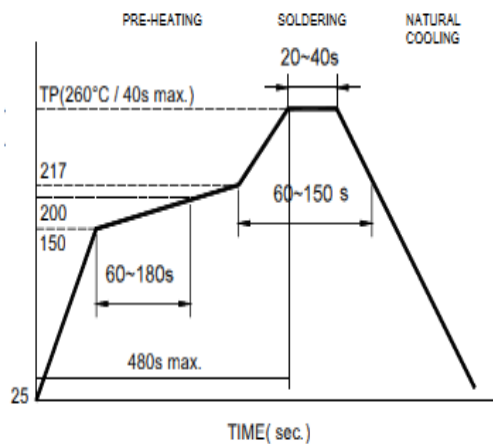

Reflow times: 3 times max.

Fig.1

Iron Soldering

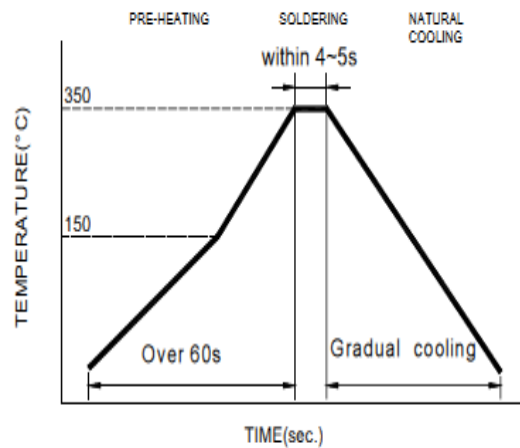

Iron Soldering times: 1 times max.

Fig.2

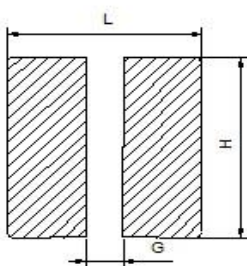
Recommended PC Board Pattern

L(mm)	G(mm)	H(mm)
2.7	0.8	2.2

ITEM P/N	PN252012T-SERIES	TEST INSTRUMENT	Agilent4291B / Agilent4338B
PRODUCT	Power Inductor	TEST FREQUENCY	1 MHz / 0.2V

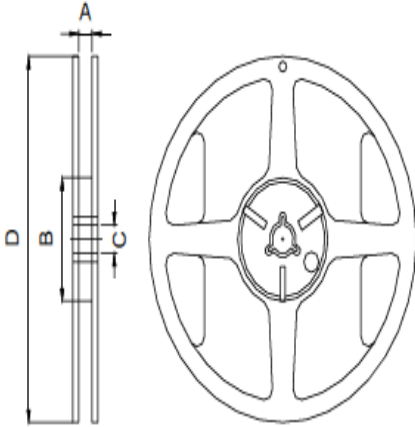
Packaging Information**Reel Dimension**

7"x8mm

Type	A(mm)	B(mm)	C(mm)	D(mm)
7"x8mm	8.4±1.0	50 min.	13±0.8	178±2

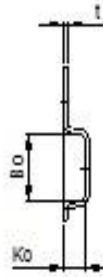
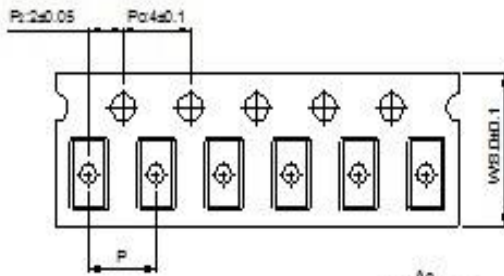

Series	Size	B0(mm)	A0(mm)	K0(mm)	P(mm)	t(mm)
PN	252012	3.10±0.1	2.45±0.1	1.40±0.1	4.0±0.05	0.23±0.05

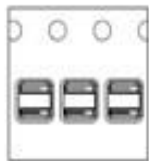
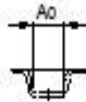

Bottom View

ITEM P/N	PN252012T-SERIES	TEST INSTRUMENT	Agilent4291B / Agilent4338B
PRODUCT	Power Inductor	TEST FREQUENCY	1 MHz / 0.2V

Packaging Information**Packaging Quantity**

Chip size	252012
Chip / Reel	2000

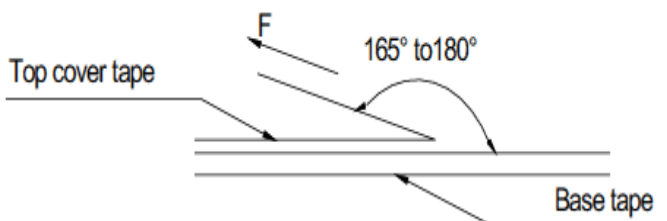
Tearing Off Force

The force for tearing off cover tape is 15 to 80 grams in the arrow direction under the following conditions.

Room Temp. (°C)	Room Humidity (%)	Room atm (hPa)	Tearing Speed mm/min
5-35	45-85	860-1060	300

- Storage Conditions

To maintain the solderability of terminal electrodes:

1. products meet IPC/JEDEC J-STD-020D standard-MSL, level 1.
2. Temperature and humidity conditions: Less than 40°C and 60% RH.
3. Recommended products should be used within 12 months form the time of delivery.
4. The packaging material should be kept where no chlorine or sulfur exists in the air.

- Transportation

1. Products should be handled with care to avoid damage or contamination from perspiration and skin oils.
2. The use of tweezers or vacuum pick up is strongly recommended for individual components.
3. Bulk handling should ensure that abrasion and mechanical shock are minimized.