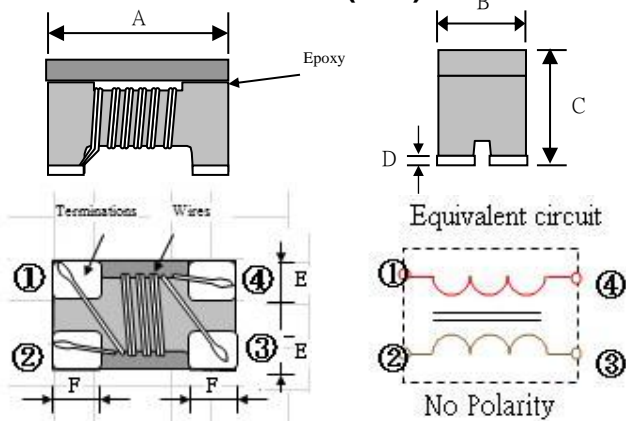

ITEM P/N	PCM4532AI-SERIES	TEST INSTRUMENT	Agilent4291B / Agilent4338B
PRODUCT	COMMON MODE CHOKE	TEST FREQUENCY	100 MHz / 0.5V

**PACKING DIMENSIONS (mm)**

4532	Dimensions
A	4.5 ± 0.2
B	3.2 ± 0.2
C	2.8 ± 0.2
D	0.2 ± 0.1
E	1.2Typ.
F	1.0Typ.

**EXPLANATION OF PART NUMBERS**

1	2	3	4	5	6	7	8	9	10	11	
P	CM	4	5	3	2	AI	-	1	0	2	S
	(1)			(2)				(3)			(4)

- (1) Product name  
 (2) Shapes and dimensions  
 (3) Impedance 【 at 100MHz 】  
 102:1000Ω  
 (4) Tolerance  
 S=±25% ; M=±20%

**ELECTRICAL CHARACTERISTICS**

P/N	Z(Ω)	DCR (Ω)	Rated current	Rated Voltage	Insulation Resistance
	Common Mode				
	Impedance at 100MHz				
	[ Max ]	Idc(A)	Vdc	IR	
	[ Max ]	[ Max ]	(V)Typical	(MΩ)Min.	
PCM4532AI-800S	80	0.07	3	50	10
PCM4532AI-121S	120	0.07	3	50	10
PCM4532AI-201S	200	0.10	2	50	10
PCM4532AI-601S	600	0.30	1.5	50	10
PCM4532AI-801S	800	0.35	1	50	10
PCM4532AI-102S	1000	0.40	1	50	10

Operating temperature : -40 to +125°C

Storage temp. and humidity : -40 to +85°C ,70%RH max

Typical Heat Rating DC Current would cause an approximately ΔT of 40°C

If Use Wave soldering is there will be some risk. Re-flow soldering temperatures below 240 degrees, there will be unwitting risk

ITEM P/N	PCM4532AI-SERIES	TEST INSTRUMENT	Agilent4291B / Agilent4338B
PRODUCT	COMMON MODE CHOKE	TEST FREQUENCY	100 MHz / 0.5V

## PERFORMANCE CURVES

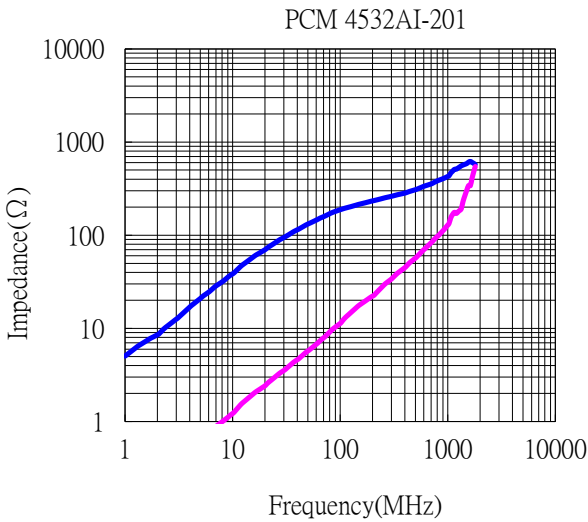
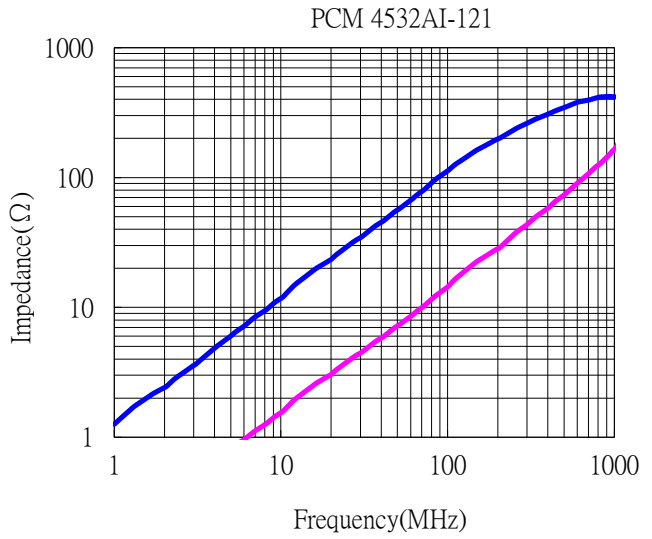
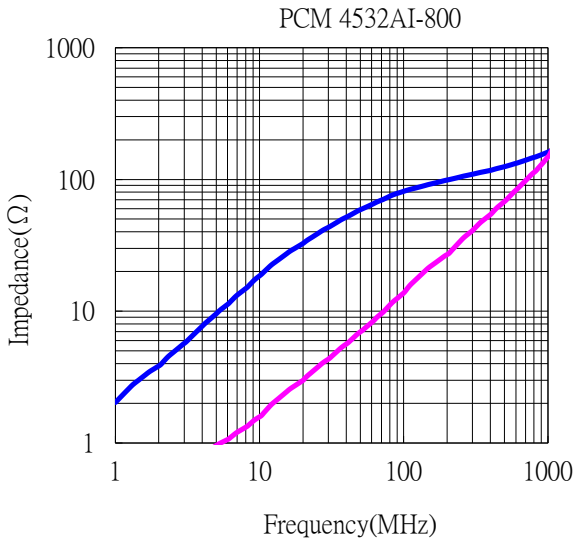

## Recommended Footprint(mm)

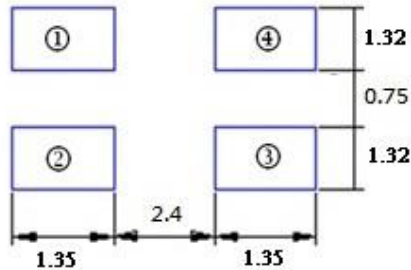
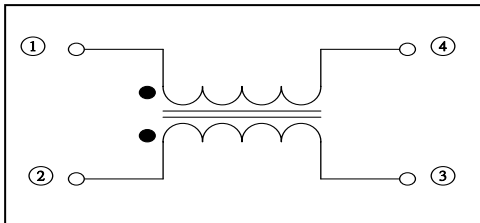

ITEM P/N	PCM4532AI-SERIES	TEST INSTRUMENT	Agilent4291B / Agilent4338B
PRODUCT	COMMON MODE CHOKE	TEST FREQUENCY	100 MHz / 0.5V

**PERFORMANCE CURVES**

PCM 4532AI-601

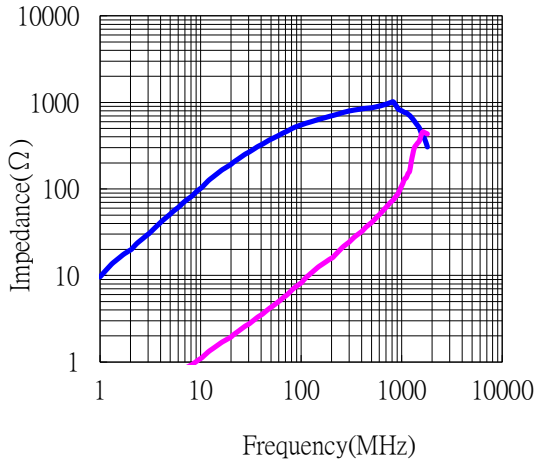

PCM 4532AI-801

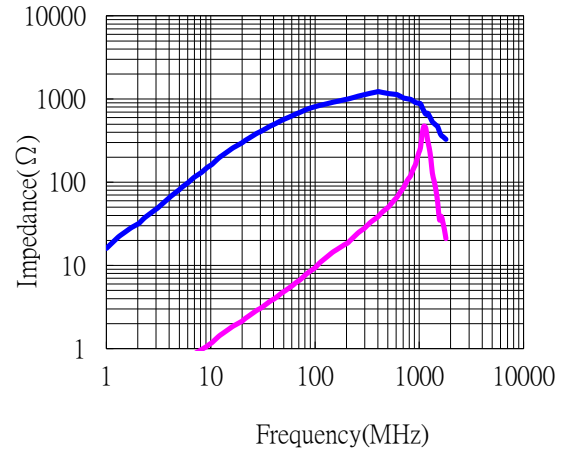

PCM 4532AI-102

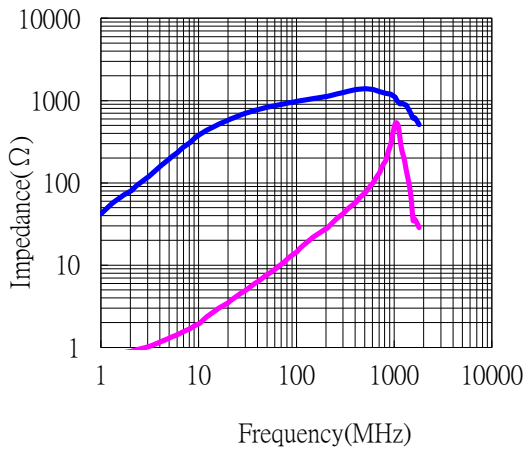

ITEM P/N	PCM4532AI-SERIES	TEST INSTRUMENT	Agilent4291B / Agilent4338B
PRODUCT	COMMON MODE CHOKE	TEST FREQUENCY	100 MHz / 0.5V

**Test Equipment****Impedance**

Measured by using Agilent 4291B RF Impedance Analyzer.

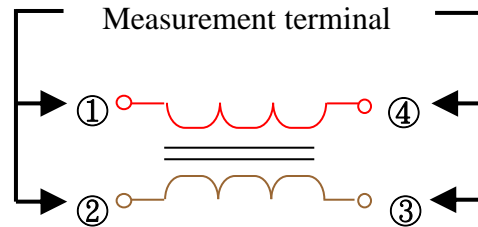
**DC Resistance**

Measurement terminal

Measured by using Agilent4338B mill ohm meter.

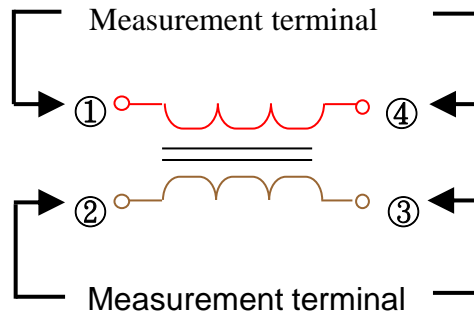
**Insulation Resistance**

Measured by using Chroma 19073

Measurement voltage : 50v ,Measurement time : 60 sec.

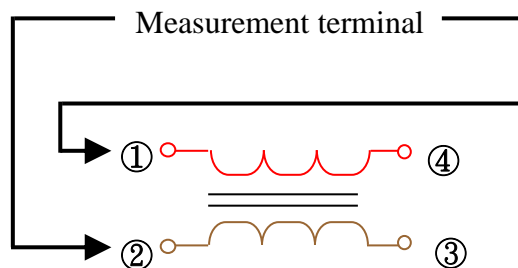

ITEM P/N	PCM4532AI-SERIES	TEST INSTRUMENT	Agilent4291B / Agilent4338B
PRODUCT	COMMON MODE FILTERS	TEST FREQUENCY	100 MHz / 0.5V

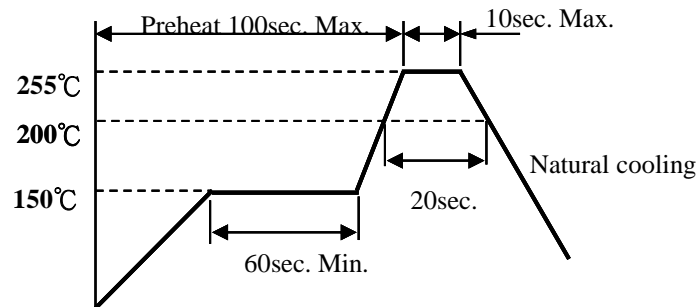
**RECOMMENDED SOLDERING TEMP. GRAPH****Reliability and Test Condition**

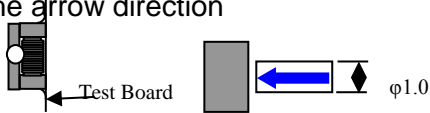
Test item	Test condition / Test method	Specification										
Resistance to soldering heat	Solder: Sn99.5%-Cu0.5% Solder temperature: 260+5/-0°C Equipment : KUNG CHENG 錫爐5" 400°C 、 RF LCR METER 。 Flux for lead free: Rosin. 9.5% 。 Dip time: 10±0.5sec. Within : 1.5mm 。 Magnification 10X 。 Test the quantity : 30pcs 。	Appearance : Cracking , chipping and any other defects harmful to the characteristics should not be allowed 。 Z: Within ±15% of initial value 。										
Solder-ability Test	Preheat: 150°C ,60sec. 。 Solder: Sn99.5%-Cu0. 5% 。 Solder temperature: 245±5°C 。 Equipment : KUNG CHENG 錫爐5" 400°C 。	Appearance : More than 95% of the terminal electrode should be covered with solder 。										
Terminal strength	Solder a chip to test substrate and then laterally apply a force in the arrow direction 	<table border="1"> <thead> <tr> <th>Series No.</th> <th>F (Kg)</th> </tr> </thead> <tbody> <tr> <td>CM1210A/D</td> <td>0.2</td> </tr> <tr> <td>CM1608A/C</td> <td>0.5</td> </tr> <tr> <td>CM2012A/B/C</td> <td>0.5</td> </tr> <tr> <td>CM3216A</td> <td>1.0</td> </tr> </tbody> </table>	Series No.	F (Kg)	CM1210A/D	0.2	CM1608A/C	0.5	CM2012A/B/C	0.5	CM3216A	1.0
Series No.	F (Kg)											
CM1210A/D	0.2											
CM1608A/C	0.5											
CM2012A/B/C	0.5											
CM3216A	1.0											

ITEM P/N	PCM4532AI-SERIES	TEST INSTRUMENT	Agilent4291B / Agilent4338B
PRODUCT	COMMON MODE CHOKE	TEST FREQUENCY	100 MHz / 0.5V

**Reliability and Test Condition**

Test item	Test condition / Test method	Specification
Temperature Cycling Test	-40 +0/-2°C, + 125 +2/-0°C Kept for 30 minutes each, 1000 cycles, Transfer Time: 5 minutes Equipment : 高新 TH-1S-C 、 RF LCR METER Test the quantity : 90pcs ◦	Appearance: Cracking, chipping any other defects harmful to the characteristics should not be allowed ◦  Z: Within ±15% of initial value ◦
Humidity Resistance Test	85~90% R.H.*25~65 +2/-0°C *10 Cycles Equipment : 高新 TH-1S-C 、 RF LCR METER Test the quantity : 90pcs ◦ Rated Current 100%	Appearance: Cracking, chipping any other defects harmful to the characteristics should not be allowed ◦  Z: Within ±15% of initial value ◦
Thermal Shock Test	CONDITION(Air-to-air) : -40 +0/-2°C, + 125 +2/-0°C Kept for 15 minutes each, 300 cycles, Transfer Time: 20 seconds Equipment : 高新 TH-1S-C 、 RF LCR METER Test the quantity : 90pcs ◦	Appearance: Cracking, chipping any other defects harmful to the characteristics should not be allowed ◦  Z: Within ±15% of initial value ◦
High Temperature Exposure	125 +0/-2°C *1000±12HRs Equipment : 高新 TH-1S-C 、 RF LCR METER Test the quantity : 90pcs ◦	Appearance: Cracking, chipping and any other defects harmful to the characteristics should not be allowed ◦  Z: Within ±15% of initial value ◦

ITEM P/N	PCM4532AI-SERIES	TEST INSTRUMENT	Agilent4291B / Agilent4338B
PRODUCT	COMMON MODE CHOKE	TEST FREQUENCY	100 MHz / 0.5V

**Reliability and Test Condition**

Test item	Test condition / Test method	Specification
Biased Humidity Test	85% R.H.*85 +2/-0°C *1000±12HRs Equipment : 高新 TH-1S-C 、 RF LCR METER Test the quantity : 90pcs ◦	Appearance: Cracking, chipping any other defects harmful to the characteristics should not be allowed ◦  Z: Within ±15% of initial value ◦
Vibration Test	It shall be soldered on substrate Oscillation Frequency: 10~2K ~10Hz for 20 minute ◦ Equipment : Vibration checker ◦ Total Amplitude: 1.52mm±10% ◦ Testing Time : 12 hours(20 min , 12 cycles each of 3 orientations) Test the quantity : 30pcs ◦	Appearance: Cracking, chipping any other defects harmful to the characteristics should not be allowed ◦  Z: Within ±15% of initial value ◦

**Application Notice**• **Storage Conditions**

To maintain the solderability of terminal electrodes:

1. products meet IPC/JEDEC J-STD-020D standard-MSL, level 1.
2. Temperature and humidity conditions: Less than 40°C and 60% RH.
3. Recommended products should be used within 6 months form the time of delivery.
4. The packaging material should be kept where no chlorine or sulfur exists in the air.

• **Transportation**

1. Products should be handled with care to avoid damage or contamination from perspiration and skin oils.

ITEM P/N	Agilent4291B / Agilent4338B	TEST INSTRUMENT	4291B - 4339B
PRODUCT	COMMON MODE CHOKE	TEST FREQUENCY	100 MHz / 0.5V

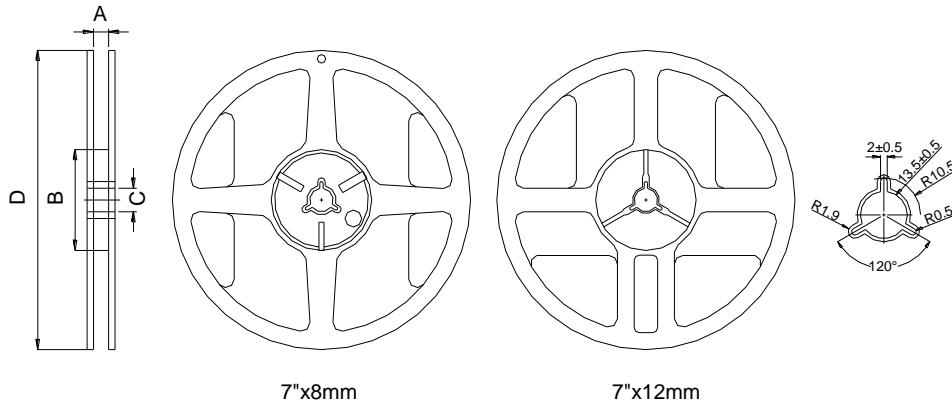
**Reel Dimension & Tape Dimension**

Type	A(mm)	B(mm)	C(mm)	D(mm)
7''x8mm	9.0±0.5	60±2	13.5±0.5	178±2
7''x12mm	13.5±0.5	60±2	13.5±0.5	178±2

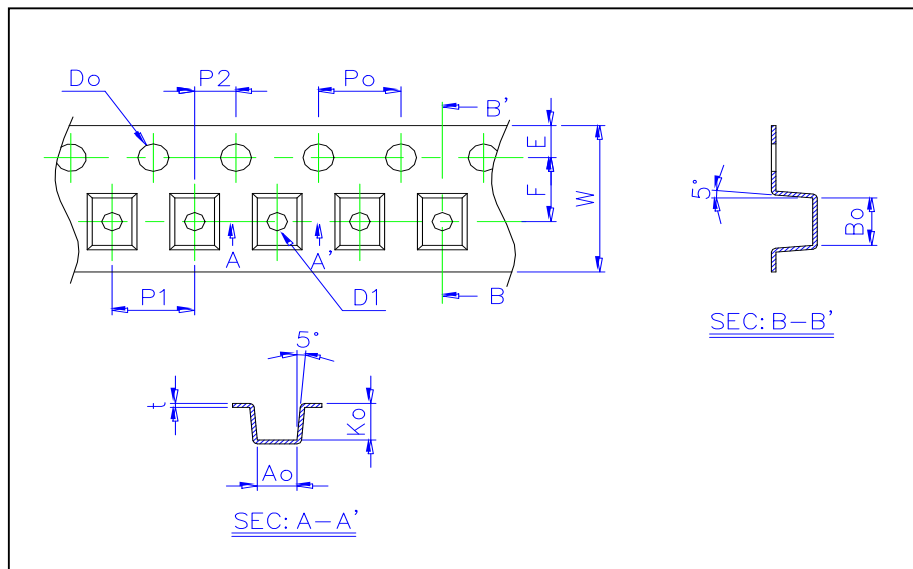

Size	Ao(mm)	Bo(mm)	Ko(mm)	W(mm)	E(mm)	F(mm)	Po(mm)	P1(mm)	Do(mm)
1608	1.00±0.10	1.65±0.10	1.18±0.10	8.00±0.20	1.75±0.10	3.50±0.05	4.0±0.05	4.0±0.10	none
2012	1.50±0.10	2.35±0.10	1.45±0.10	8.00±0.20	1.75±0.10	3.50±0.05	4.0±0.05	4.0±0.10	1.0±0.1
3216	1.88±0.10	3.50±0.10	2.10±0.10	8.00±0.20	1.75±0.10	3.50±0.05	4.0±0.05	4.0±0.10	1.0±0.1
4532	4.90±0.10	3.45±0.10	3.05±0.10	12.00±0.20	1.75±0.10	5.50±0.05	4.0±0.05	8.0±0.10	1.5+0.1,-0

**Packaging Quantity**

Chip Size	1608	2012	3216	4532
8mm/ Reel	2000	2000	2000	500